

# moj novi minimulti



**Dani letu!**

## Dani tajedna

Memo je napisao dane tajedna u kalendar.  
Na žalost je pomišao slove. Popravi!

Jedan tajedan ima \_\_\_\_\_ dan!

# 2013

oepniadlj <del>k</del>	
trauok	
rjeidsa	
etačvtrk	
tekap	
uotbas	
dnljiae	



Išći dane u kalendaru!

- 1. januar je ljetos \_\_\_\_\_ .
- 1. maj je ljetos \_\_\_\_\_ .
- 26. oktobar je ljetos \_\_\_\_\_ .
- 1. novembar je ljetos \_\_\_\_\_ .
- 24. decembar je ljetos \_\_\_\_\_ .



## Dobe dana

Memo je napisao dobe dane.  
Pročitaj riči i napiši rečenice!

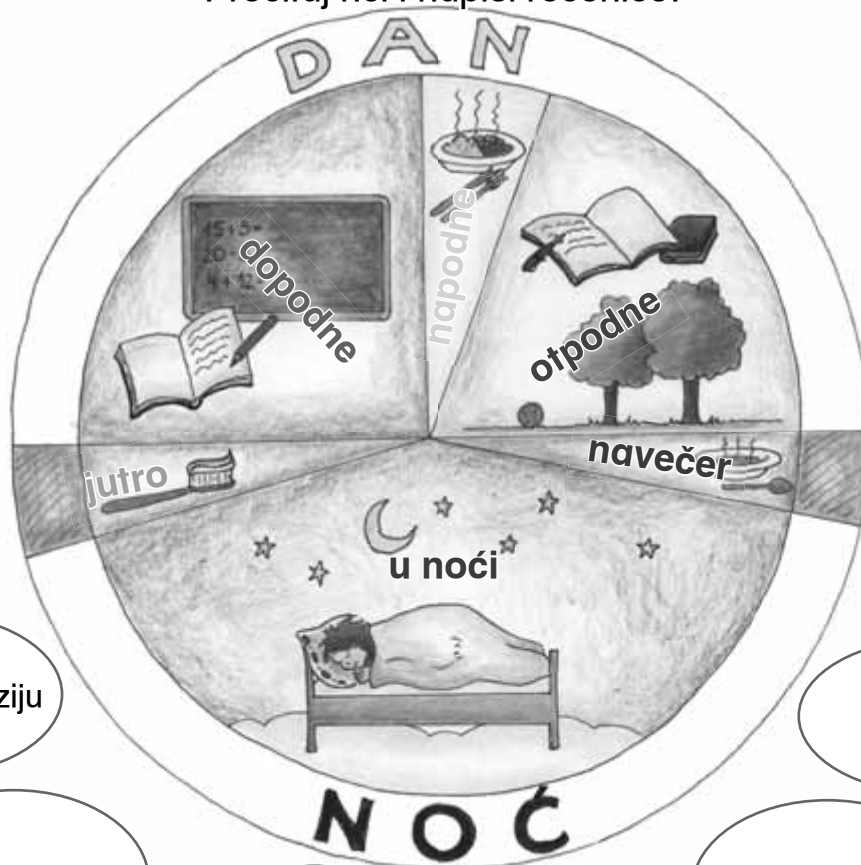

gledati televiziju

spavati

zbuditi se

čistiti si zube

pisati i računati

pisati zadaću

objedvati

igrati se vani

večerati



**Dodili riči/glagole sliki i poфарbaj krugе odgovarajućom фарbom!**  
Napiši rečenice u svoju pisanku: **Jutro se zbudim.**

upoznati dobe dana  
tvoriti rečenice i je napisati u pisanku

minimulti novi moj

### Snižne pahuljice letu

Ke/Koje slove slišu skupa?  
Pomoljaj je istom farbom!

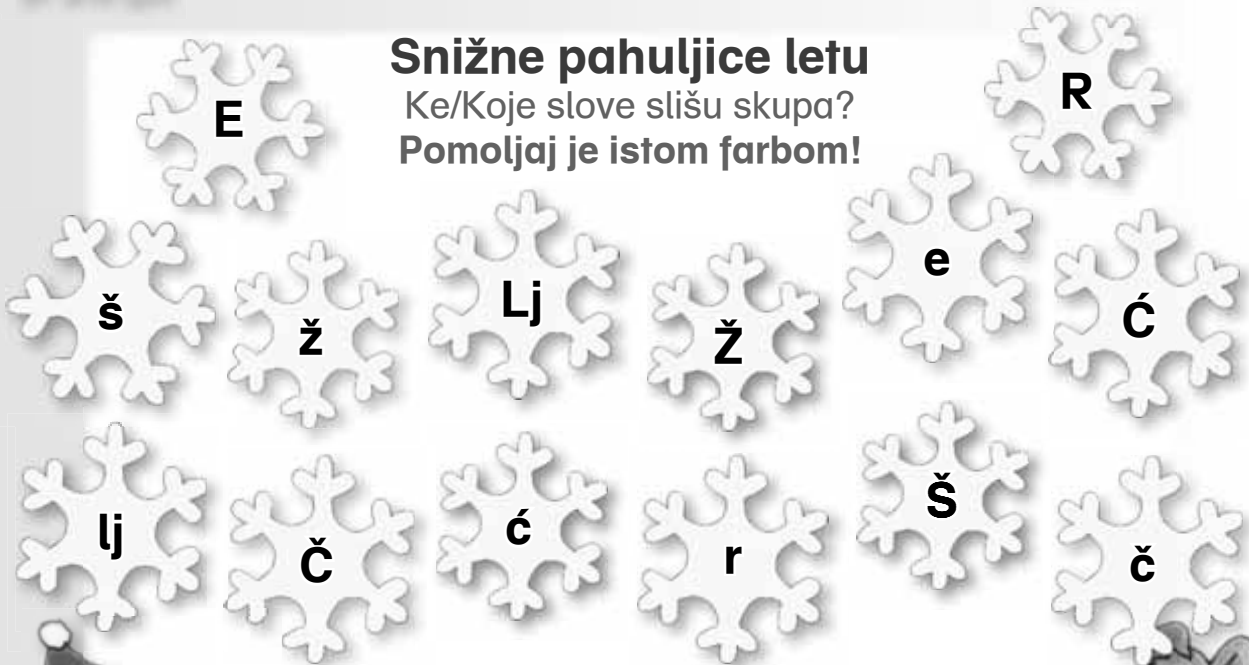

Išči riči i napiši je pod sliku!

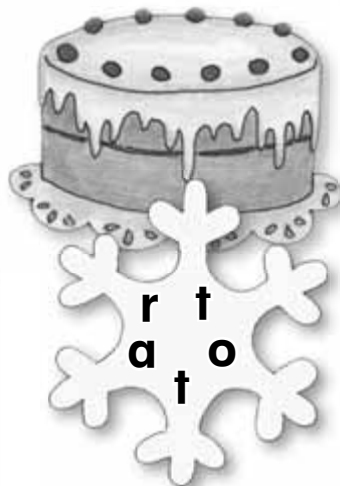



krljača



mrkva



rukavice



šal



kapica



gumbice

## Obliči snigoviće

Čitaj točno i pojarbaj snigoviće!

U vrtu stoju tri snigovići. Prvi se zove **Miško**, drugi **Ivo**, a treći **Toni**. Rado si obliču šaro rublje.

**Miško** ima plavu krljaču. **Ivo** si nasadi zelenu kapicu. **Toni** ima na glavi črljenu kapicu. Oko vrata si **Miško** sveže lilast šal. **Ivo** ima žut šal. **Toni** ima kafecak šal. **Miško** nosi na ruka rozaste rukavice.

**Ivo** nosi črne rukavice. Svaki ima četire gumbice. **Miškine** gumbice su zelene, a **Ivine** su črljene.

**Toni** ima plave gumbice. Trimi imaju orandžast nos. Jednomu je jako mrzlo. Zato mu je nos plav.

Gledaj točno!  
Gdo je to?



čitati točno  
razumiti i pojarbati

minimulti novi moj

### Na mesopusnom balu

Nadopuni točke, upitnike i uzvičnike!  
Napiši odgovarajuću rič pod sliku!



Ne tako glasno \_\_\_\_\_

\_\_\_\_\_



Prosim, tancaj  
s manom \_\_\_\_\_



Kade je  
moja metla \_\_\_\_\_

\_\_\_\_\_



Ja znam čarat

\_\_\_\_\_



Znaš i ti kuhati \_\_\_\_\_

\_\_\_\_\_



Rado se smijem \_\_\_\_\_

\_\_\_\_\_

kloun

viška

kuhar

princezka

policajac

čarobnjak



## Snigović

Potcrtaj u ovom tekstu sve glagole!  
Napiši ov tekst u prošlom vrimenu!

Danas pada mnogo sniga. Marko i Ana se sankaju i šijaju na brigu. Julijan se fuza na ledu. Ivo pozove svoje prijatelje k sebi. Skupa napravu snigovića. Julijan načini veliku grudu. I Ana rulja grudu i ju postavi na tijelo. Marko načini ruke. Dica donesu stari lonac, metlu, mrkvu i ugljena. Snigović je vrijeda gotov.

rati\_\_\_\_\_

**Kad je Ana domom došla, je majki povidala:**

„Danas je palo mnogo sniga. Marko i ja smo se sankali i

\_\_\_\_\_ na brigu. Julian se \_\_\_\_\_ na ledu.

Ivo \_\_\_\_\_ svoje prijatelje k sebi.

Skupa \_\_\_\_\_ snigovića.

Julian \_\_\_\_\_ veliku grudu.

I ja \_\_\_\_\_ grudu i \_\_\_\_\_

ju na tijelo. Marko \_\_\_\_\_ ruke.

Dica \_\_\_\_\_ stari lonac, metlu, mrkvu i ugljena.

Snigović je \_\_\_\_\_ vrijeda gotov.“



tvoriti rečenice u prošlom vrimenu  
znati hasnovati prošlo vrime

minimulti novi moj

## Nakane za novo ljeto

Laura i Fabijan imaju dobre nakane za novo ljeto.

**Laura:** Fabijan, ku/koju nakanu imaš ti za novo ljeto?

**Fabijan:** Ja kanim u školi bolje paziti. A ti Laura?

**Laura:** Da, ja ću se trsiti da se ranije stanem.

**Fabijan:** Da, zadnju srijedu si došla prekasno!

**Laura:** Zato ću se od sada stati ranije.

A ti Fabijan, ti se moreš odreći slatkarije!

To će biti bolje za tvoje zdravlje.

**Fabijan:** Imaš pravo. Danas je ponedjeljak, ili?

Od danas ću se odreći slatkarije!

**Laura:** Ja imam još jednu nakanu!

Svaku subotu ću napraviti

uredbu u svojoj sobi.

**Fabijan:** Pridružit ću se i ja ovoj tvojoj nakani:

**Fabijan i Laura:** Ufamo se, da će nam se ovo ugodati!

**Imaš i ti neke nakana za novo ljeto?**

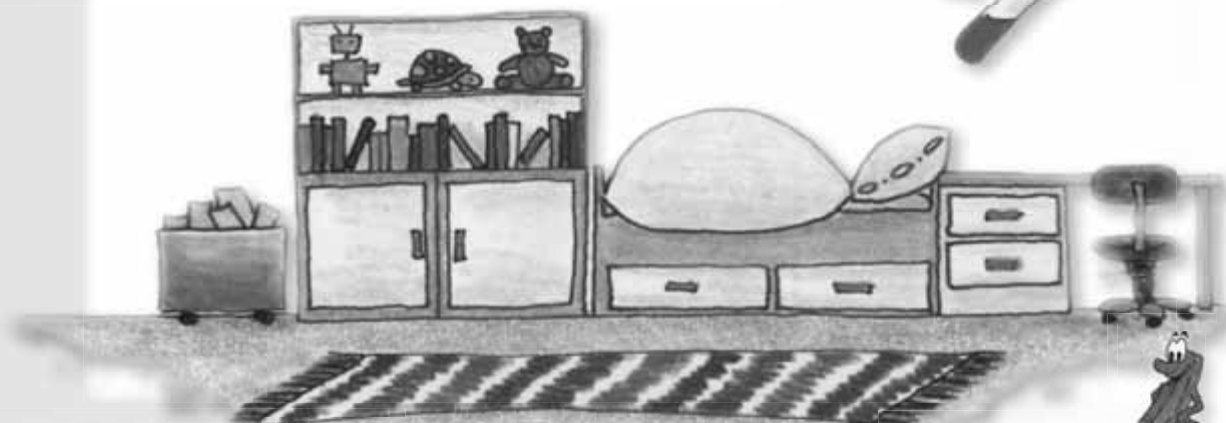



## Šalna pitanja

Čitaj i prekriži pravilni odgovor!

### Okruglo je.

Mnogoput je bijelo.  
Potrebno je za jilo.

misec



labda



tanjir



### Jako vruće je.

Daleko je od nas.  
Daje nam svitlo i toplinu.

juha



sunce



lampa



### Veliko je.

Brzo se vozi.  
Ima četire kotače.

bicikl



lokomotiva



auto



### Visi na stablu.

Žuto, črљeno i zeleno je.  
Okruglo i ukusno je.

labda



opica



jabuka



### Malo je.

Brzo je.  
Suro, kafecko ili bijelo je.

mačka



miš



zec



### Važno je za tebe.

Svaki ima samo jedno.  
Ti njim dušiš.

uho



usta



nos



čitati i opisati  
šalna pitanja

minimulti novi moj

## Snigovići

Čitaj broje i poveži pravilno!



13	15	17	12	14	11	16	18	20	19
----	----	----	----	----	----	----	----	----	----



Računaj i napiši odgovarajuću slovu u ormarić!

10	2	6	5	13	4	11	18	3	9	14	7
A	S	S	N	Z	A	I	A	N	I	M	G



$10 + 3 =$		$10 + \underline{\quad} = 12$		$16 - \underline{\quad} = 10$	
$10 + 1 =$		$10 + \underline{\quad} = 15$		$20 - \underline{\quad} = 10$	
$10 + 4 =$		$10 + \underline{\quad} = 19$		$13 - \underline{\quad} = 10$	
$10 + 8 =$		$10 + \underline{\quad} = 17$		$14 - \underline{\quad} = 10$	



## Matematična tijela

kvader, kocka (kubus), piramida

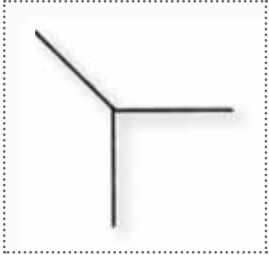
**matematični izrazi:**

<b>kut/Ecke</b>	<b>brid/Kante</b>	<b>površina/Fläche</b>
		

**Ispuni – ča/što si zapameti/la?**

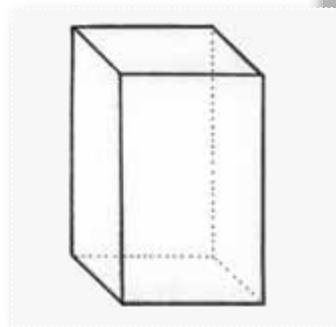
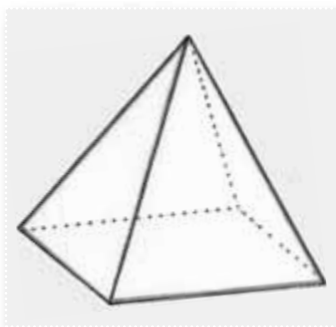
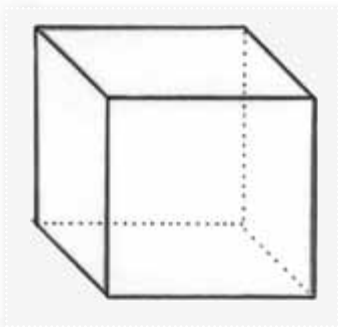

<b>ime:</b>	
<b>koliko?</b>	
<b>kutov:</b>	
<b>bridov:</b>	
<b>površin:</b>	

<b>ime:</b>	
<b>koliko?</b>	
<b>kutov:</b>	
<b>bridov:</b>	
<b>površin:</b>	

<b>ime:</b>	
<b>koliko?</b>	
<b>kutov:</b>	
<b>bridov:</b>	
<b>površin:</b>	





**Kauboj  
pije!**



**Princ  
se igra!**



**Princeska  
tanca!**



**Mačka  
jači!**



**Klaun  
skače!**



**Šerif  
čita!**



**Viška  
pije!**



**Kauboj  
tanca!**

domino ili memori  
domino, kade hoćeš!



**Črljen-  
kapica  
čita!**



**Indijanac  
jači!**



**Čarobnjak  
žonglira!**



**Kuhar  
skače!**



**Zec  
spava!**



**Kuharica  
spava!**



**Miš  
se igra!**



**Miš  
žonglira!**

glagol! Čuda veselja!

minimulti novi moj

## Skači gumicom!

Gibanje i šport

Troja dica tribaju 1 gumicu, ka/koja je oko 2m duga i 1cm debela.

Povežite ju na kraji skupa!

Dvoja dica ju nategnu nogami.

Treće dite skače dvimi nogami najjednoč u ritmu zbrajalice.

**Gledaj na slike!**

Ako se dotakneš gumice, je drugo dite na red.

Kada su svi bili na redu, se gumica podigne više.

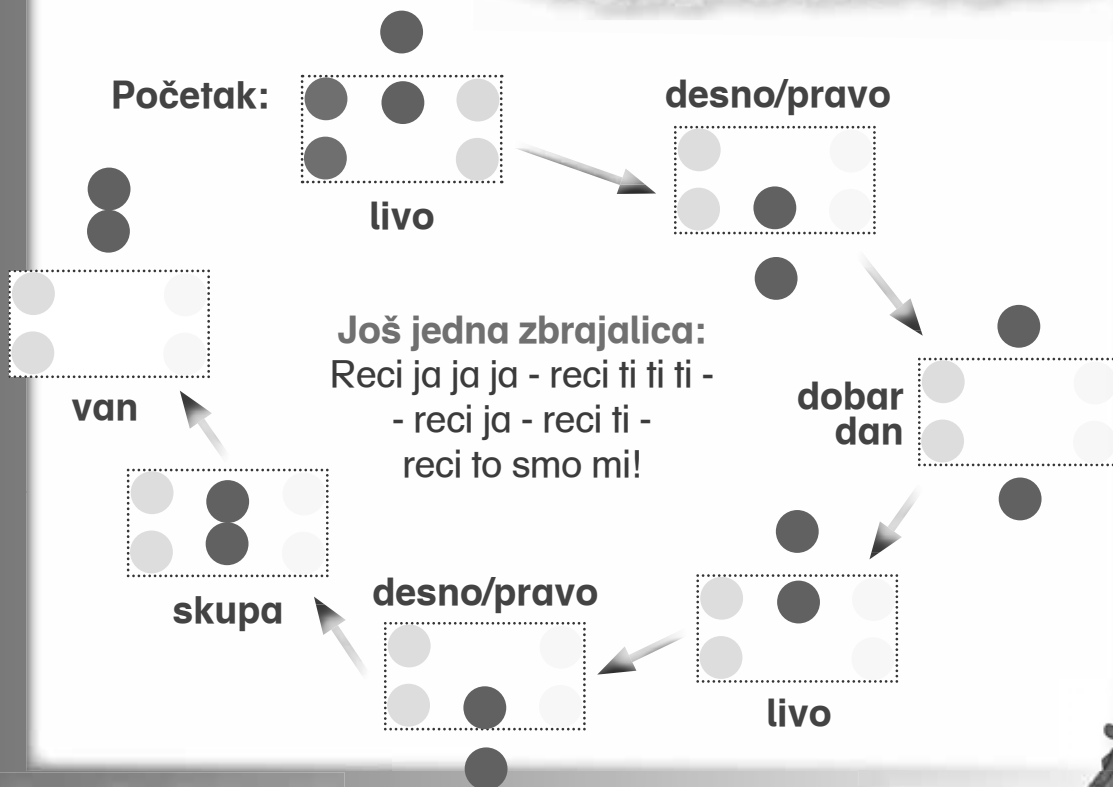
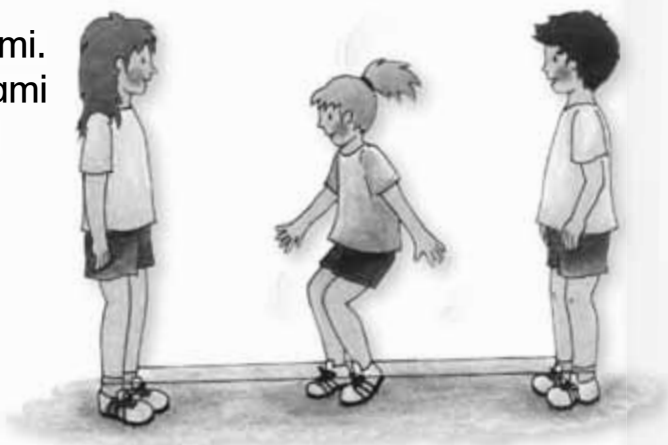

## Mesopusne maske

Dobru i lipu zabavu!

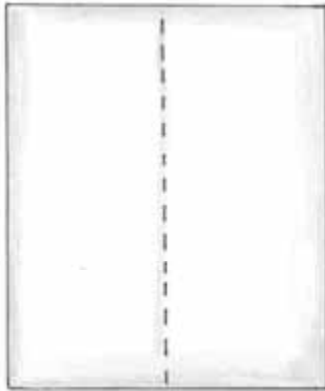

### Ti pravaš:

- bijeli list (A 3)
- olovku i brisalicu
- škare
- vodene farbe
- male iglice

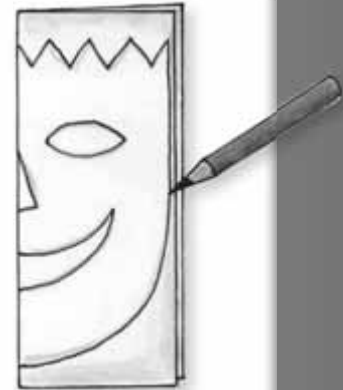

### Djelaj ovako:

Prekreni list u sredini!

Namoljaj samo pol obraza na list

(vlase, jedno oko, pol nosa, pol ust i pol brade)!

Onda izriži masku!

Pri oku moraš prebosti list i pažljivo rizati.

Pofarbaj masku različnim farbami!

Čekaj, dokle se farbe usušu!

Na zadnje zami iglice i ubisi svoju masku u razredu!

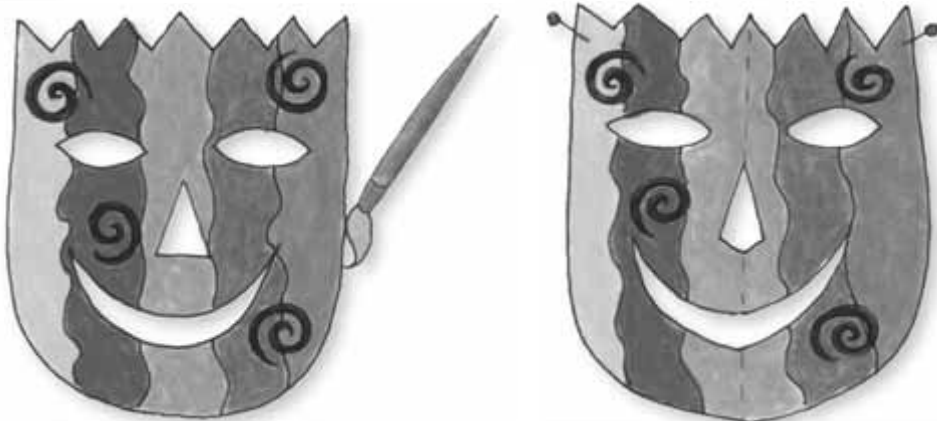

čitati i djelati  
po nalogu

minimulti novi moj

H  
 J  
 K  
 U

Andjeo je rekao Jožefu da pobigne u Egipat. Kako ćedu sigurno stignuti u Egipat? Zač/Zašto su morali pobignuti?  
**Ako najdeš pravilne slove i je napišeš u ormarić, imaš odgovor!**

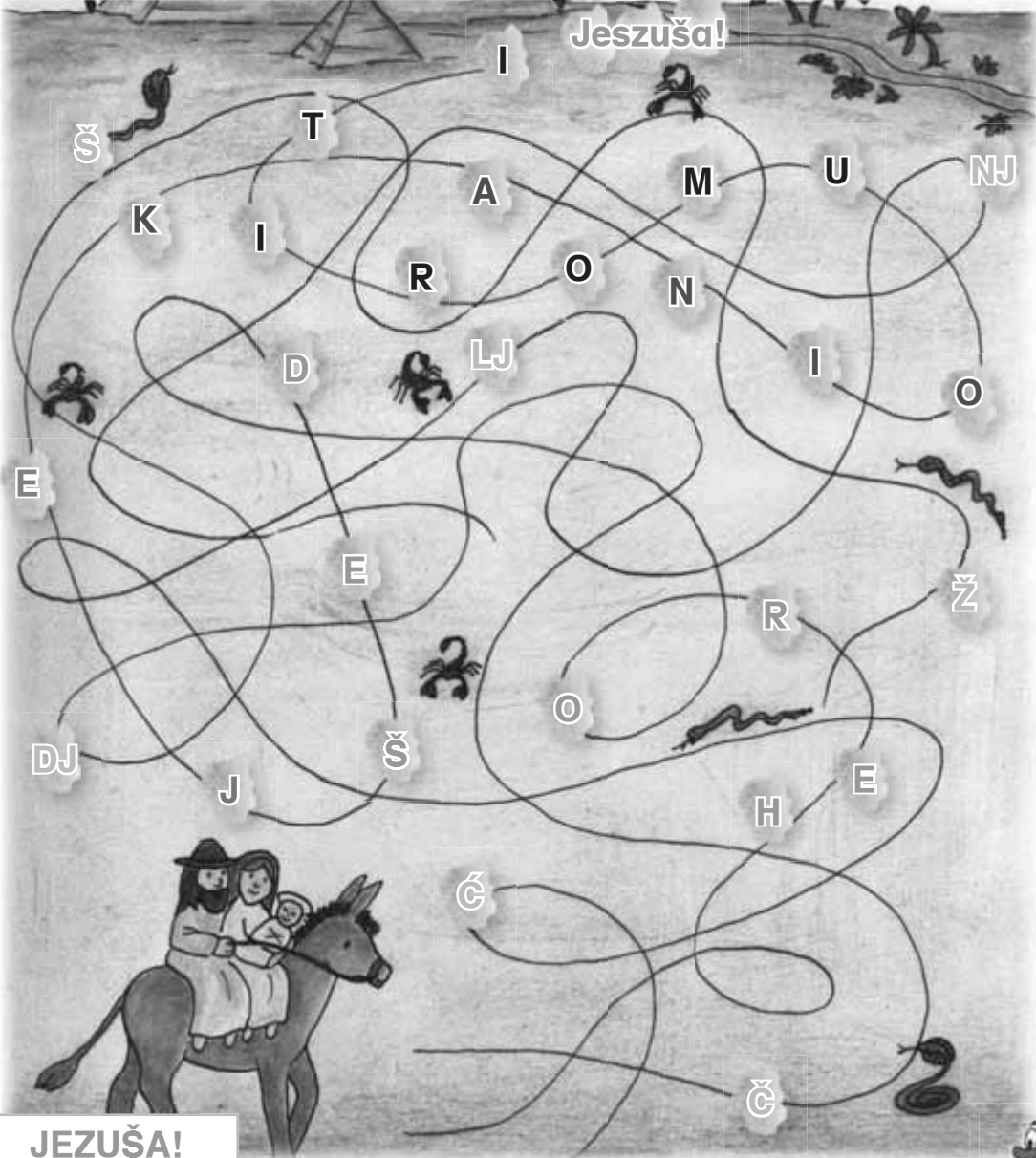

**JEZUŠA!**





Kad je Herodeš umro, se je vratila Sveta obitelj opet u Nazaret.

Jožef je djelao kot drivodjelac.

**Moreš li najti u njegovoj radionici sedam pogriškov?**

**Prekriži i napiši riči u tvoju pisanku!**



iskati pogriške

minimulti novi moj

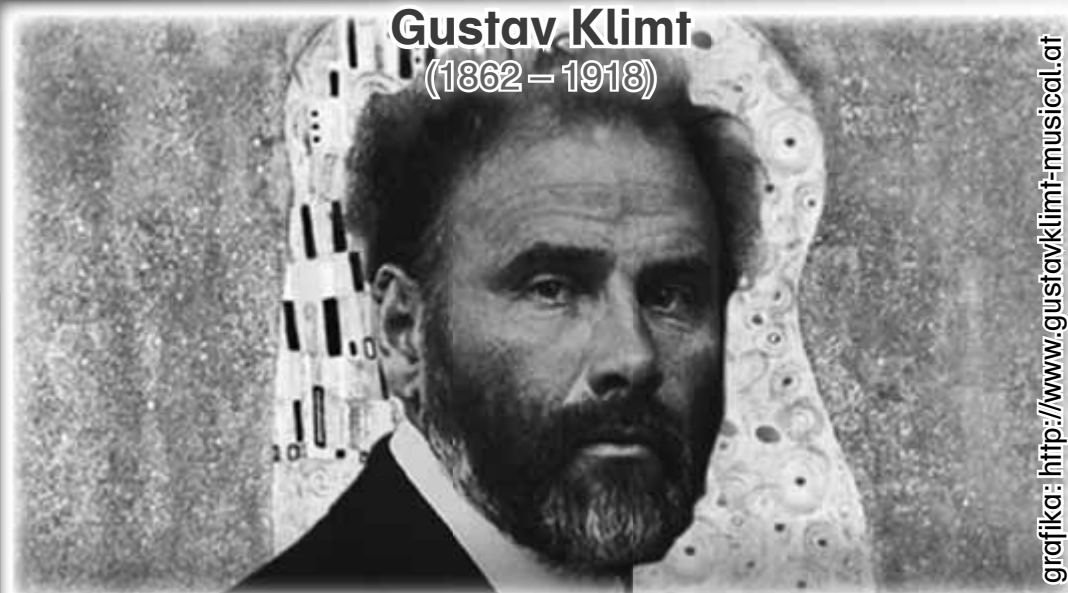

**Gustav Klimt**  
(1862 – 1918)

grafika: <http://www.gustavklimt-musical.at>

### Precrtaj nepravilne izjave!

U prošlom ljetu smo slavili **S)** 150 **T)** 250. obljetnicu Klimtovoga rođenja. Gustav Klimt je živio **E)** u Beču **F)** u Solnogradu. **C)** U ljeti **D)** U zimi je bio na jezeru u Gornjoj Austriji (Attersee). **D)** Klimt je bio oženjen, ali nije imao dice. **E)** Klimt nije bio oženjen, ali je imao već dice. Klimt je bio umjetnik, ki/koje je glavno slikao **R)** uaturi **S)** u ateljeu. Glavno je slikao **S)** žene **T)** cvijeće. Njegova najdraža farba je bila **G)** črna **H)** zelena **I)** zlata farba. Nosio je rado **N)** ugodne hlače **O)** dužičke haljine. Njegova najpoznatija slika se zove **N)** poljubac **O)** objamljenje.

Ako napišeš pravu slovu u kocku,  
ćeš doznati, ko/koje umjetno društvo je utemeljio Gustav Klimt!

W	I	E	N	E	R	S											
---	---	---	---	---	---	---	--	--	--	--	--	--	--	--	--	--	--





Klimt je slikao lijepe žene. Njeva oprava je imala svenek izvanredne mustre i farbe. Pofarbaj opravu ove žene po svojem ukusu.

**Tip:** Zalipi sliku na papir i napravi sliku u Klimtovom stilu kot su to djelali školari i školarice trećega/tretoga razreda Dvojezične nove sridnje škole Veliki Borištof!



školarica Sabina Kukuljac



školar Daniel Kuzmits



pofarbati opravu  
pokusiti napraviti Klimtov stil

minimulti novi moj

*Primos Nore Sindije Škole Veliki Borištof*

## Naše Gradišće

Kotari i automobilne pločice.  
Ispuni, ča/što skupa sliši!

 **ND**  **Niuzaljski kotar**

  **Novogradski kotar**

  **Bortanski kotar**

  **Željezanski kotar**

  **Gornjopuljanski kotar**

  **Matrštofski kotar**

  **Jenrštofski kotar**

  **Grad Željezno i**

  **Rušta**

imaju posebne  
automobilne  
pločice!

moj novi minimulti

dobiti informacije  
o svojoj saveznoj zemlji



### Sudoku notov

Ke/Koje note falu? Ispuni sudoku!

igrati se sudoku  
poznati i pisati note

minimulti novi moj

## Idemo se šijati!

Ča/Što se triba pri šijanju? Okruži ili prekriži!  
Vježbaj ovako: Tribam kacigu. Tribam ...



Upoznaj  
moj kalendar!

## Naš tip: Zidni kalendar 2012./13.

Memo u školi

Svaki razred je dostao kalendar s naslovom „Memo u školi“. U ovom kalendaru vas Memo na šalni način pelja kroz školsko ljeto.

Čuda veselja pri učnji!



Izdavač ovoga kalendara je

Hrvatski kulturni

i

dokumentarni centar.

[www.croates.at](http://www.croates.at)

[hkdc@croates.at](mailto:hkdc@croates.at)

upoznati zidni kalendar  
Memo u školi

minimulti novi moj

## Kompjutorski „a-b-c“

„paint it!“ slikovni program za ducu

Poduzeće Microsoft je napravilo jedan program, kade dica moru na jednostavni i šalni način upoznati principe za slikanje/moljanje na kompjutoru.

Ov program ima skoro sve mogućnosti, ke/koje ima i slikovni program za odrasle, samo na dičjoj razini. **Paint it!** se ne triba inštalirati, samo krenuti iz medijuma; zanimljivo i šalno i za odrasle, ki/koji se rado bavu grafikom na kompjutoru. U svitskoj digitalnoj mriži egzistiraju slobodne verzije ovoga produkta, samo se mora iskati na tražilici.



## Kazalo

Dani tajedna.....	2
Dobe dana.....	3
Snižne pahuljice letu.....	4
Oblići snigoviće.....	5
Na mesopusnom balu.....	6
Mesopusna ganjka.....	7
Snigović.....	8
Šalna pitanja.....	9
Snigovići.....	10
Matematična tijela.....	11
Mesopusni domino ili memori.....	12
Mesopusni domino ili memori.....	13
Skači gumicom!.....	14
Mesopusne maske.....	15
Institit za vjerskopedagošku izobrazbu.....	16
Institit za vjerskopedagošku izobrazbu.....	17
Gustav Klimt - prinos NSŠ Veliki Borištof.....	18
Gustav Klimt - prinos NSŠ Veliki Borištof.....	19
Naše Gradišće.....	20
Sudoku notov.....	21
Idemo se šijati!.....	22
Naš tip: Zidni Kalendar 2012./13.....	23
Kompjutorski „a-b-c“ „paint it!“.....	24



**Vlasnik i izdavač / Medieninhaber und Herausgeber:** © 2013. HNVŠ  
Narodna visoka škola gradišćanskih Hrvatov - <http://www.vhs-croates.at>  
Volkshochschule der burgenländischen Kroaten, 7000 Eisenstadt, J. Permaystr. 9



**Odgovorno uredništvo:** Arth Elfriede, Billisits Martina, Bunyai, MAS, MSc Stefan, Buranits Helene, Dorner Patricia, Heisinger, Mag. Elvira, Imre Manuela, Marlovits Michael, Marlovits Heidemarie, Sagmeister Juliane, Varga Marlen, Zsivkovits Silvia

**Lektorica:** Mag.<sup>ra</sup> Edith Mühlgaszner, MAS, HR<sup>in</sup>, LSI<sup>in</sup> i.R.

**Ilustracije:** Gabriel Jasmine - **Layout i slog:** Bunyai, MAS, MSc Stefan

*Opog* minimulti digital: <http://www.bildungsserver.com/schulen/minimulti/default.htm>

**Poštanski ured ishadjanja:** 7000 Željezno, **Tiskara:** Wograndl Druck, 7210 Matrštof

**Izjava polag Zakona o mediji:** „moj novi minimulti“ je časopis za školare/školarice u Gradišću.

**Erklärung gemäß Mediengesetz:** „moj novi minimulti“ ist eine Zeitschrift für SchülerInnen im Burgenland, verfasst in kroatischer Sprache. Gefördert vom Bundeskanzleramt aus Mitteln der Volksgruppenförderung.

