

moj novi minimulti



Dani letu!

Dani tajedna

Memo je napisao dane tajedna u kalendar.

Na žalost je pomišao slove. Popravi!

Jedan tajedan ima _____ dan!

2013

oepniadljik	
trauok	
rjeidsa	
etačvtrk	
tekap	
uotbas	
dnljiae	



Išći dane u kalendaru!

1. januar je ljetos _____ .
1. maj je ljetos _____ .
26. oktobar je ljetos _____ .
1. novembar je ljetos _____ .
24. decembar je ljetos _____ .



Dobe dana

Memo je napisao dobe dane.

Pročitaj riči i napiši rečenice!

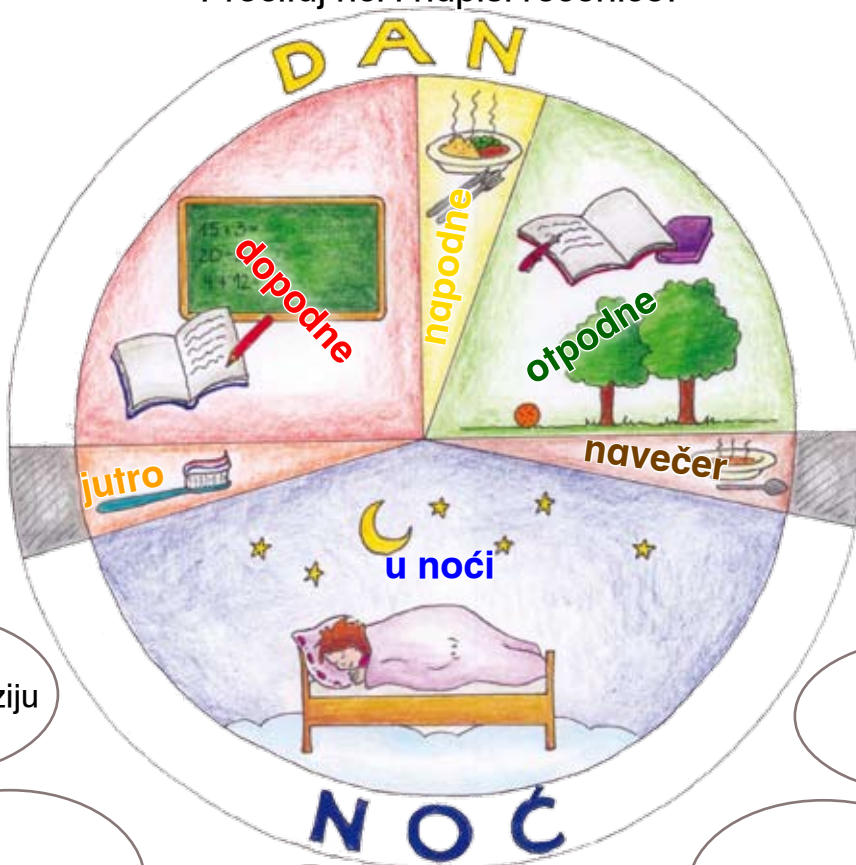

gledati televiziju

spavati

zbuditi se

čistiti si zube

pisati i računati

pisati zadaću

objedvati

igrati se vani

večerati

Dodili riči/glagole sliki i pofarbaj kruge odgovarajućom farbom!

Napiši rečenice u svoju pisanku: Jutro se zbudim.



upoznati dobe dana
tvoriti rečenice i je napisati u pisanku

minimulti novi moj

Snižne pahuljice letu

Ke/Koje slove slišu skupa?

Pomoljaj je istom farbom!



Išči riči i napiši je pod sliku!





krljača

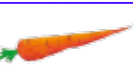

mrkva



rukavice



šal



kapica



gumbice

Obliči snigoviće

Čitaj točno i pođarđaj snigoviće!

U vrtu stoju tri snigovići. Prvi se zove **Miško**, drugi **Ivo**, a treći **Toni**. Rado si obliču šaro rublje.

Miško ima plavu krljaču. **Ivo** si nasadi zelenu kapicu. **Toni** ima na glavi črljenu kapicu. Oko vrata si **Miško** sveže lilast šal. **Ivo** ima žut šal. **Toni** ima kafecak šal. **Miško** nosi na ruka rozaste rukavice.

Ivo nosi črne rukavice. Svaki ima četire gumbice. **Miškine** gumbice su zelene, a **Ivine** su črljene. **Toni** ima plave gumbice. Trimi imaju orandžast nos. Jednomu je jako mrzlo. Zato mu je nos plav.

Gledaj točno!
Gdo je to?



čitati točno
razumiti i pođarđati

minimulti novi moj

Na mesopusnom balu

Nadopuni točke, upitnike i uzvičnike!
Napiši odgovarajuću rič pod sliku!



Ne tako glasno _____

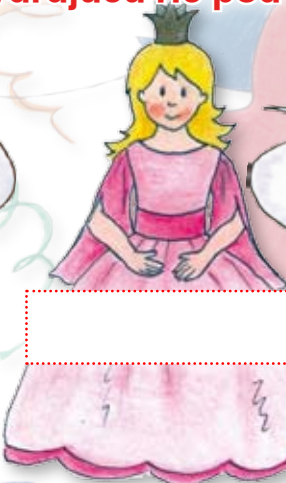

Prosim, tancaj
s manom _____



Kade je
moja metla _____



Znaš i ti kuhati _____



Rado se smijem _____

klaun

viška

kuhar

princeška

policajac

čarobnjak



Snigović

Potcrtaj u ovom tekstu sve glagole!
Napiši ov tekst u prošlom vremenu!

Danas pada mnogo sniga. Marko i Ana se sankaju i šijaju na brigu. Julijan se fuza na ledu. Ivo pozove svoje prijatelje k sebi. Skupa napravu snigovića. Julijan načini veliku grudu. I Ana rulja grudu i ju postavi na tijelo. Marko načini ruke. Dica donesu stari lonac, metlu, mrkvu i ugljena. Snigović je vrijeda gotov.

ati_____

Kad je Ana domom došla, je majki povidala:

„Danas je palo mnogo sniga. Marko i ja smo se sankali i

_____ na brigu. Julian se _____ na ledu.

Ivo _____ svoje prijatelje k sebi.

Skupa _____ snigovića.

Julian _____ veliku grudu.

I ja _____ grudu i _____

ju na tijelo. Marko _____ ruke.

Dica _____ stari lonac, metlu, mrkvu i ugljena.

Snigović je _____ vrijeda gotov.“



Nakane za novo ljeto

Laura i Fabijan imaju dobre nakane za novo ljeto.

Laura: Fabijan, ku/koju nakanu imaš ti za novo ljeto?

Fabijan: Ja kanim u školi bolje paziti. A ti Laura?

Laura: Da, ja ću se trsiti da se ranije stanem.

Fabijan: Da, zadnju srijedu si došla prekasno!

Laura: Zato ću se od sada stati ranije.

A ti Fabijan, ti se moreš odreći slatkarije!
To će biti bolje za tvoje zdravlje.

Fabijan: Imaš pravo. Danas je ponedjeljak, ili?
Od danas ću se odreći slatkarije!

Laura: Ja imam još jednu nakanu!
Svaku subotu ću napraviti
uredbu u svojoj sobi.

Fabijan: Pridružit ću se i ja ovoj tvojoj nakani:

Fabijan i Laura: Ufamo se, da će nam se ovo ugoditi!

Imaš i ti neke nakana za novo ljeto?



Šalna pitanja

Čitaj i prekriži pravilni odgovor!

Okruglo je.

Mnogoput je bijelo.
Potrebno je za jilo.

misec



labda



tanjir



Jako vruće je.

Daleko je od nas.
Daje nam svitlo i toplinu.

juha



sunce



lampa



Veliko je.

Brzo se vozi.
Ima četire kotače.

bicikl



lokomotiva



auto



Visi na stablu.

Žuto, črlijeno i zeleno je.
Okruglo i ukusno je.

labda



opica



jabuka



Malo je.

Brzo je.
Suro, kafecko ili bijelo je.

mačka



miš



zec



Važno je za tebe.

Svaki ima samo jedno.
Ti njim dušiš.

uho



usta



nos



Snigovići

Čitaj broje i poveži pravilno!



13	15	17	12	14	11	16	18	20	19
----	----	----	----	----	----	----	----	----	----



Računaj i napiši odgovarajuću slovu u ormarić!

10	2	6	5	13	4	11	18	3	9	14	7
A	S	S	N	Z	A	I	A	N	I	M	G

$10 + 3 =$	
$10 + 1 =$	
$10 + 4 =$	
$10 + 8 =$	

$10 + \underline{\quad} = 12$	
$10 + \underline{\quad} = 15$	
$10 + \underline{\quad} = 19$	
$10 + \underline{\quad} = 17$	

$16 - \underline{\quad} = 10$	
$20 - \underline{\quad} = 10$	
$13 - \underline{\quad} = 10$	
$14 - \underline{\quad} = 10$	



Matematična tijela

kvader, kocka (kubus), piramida

matematični izrazi:

kut/Ecke

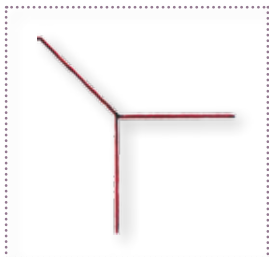

brid/Kante

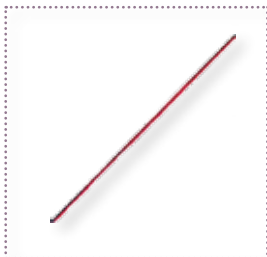

površina/Fläche

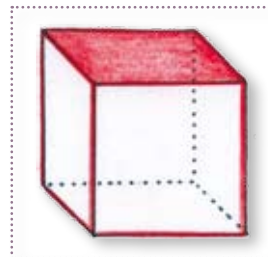

Ispuni – ča/što si zapameti/la?

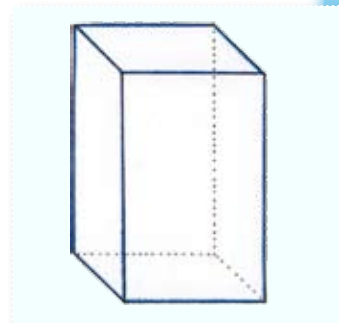
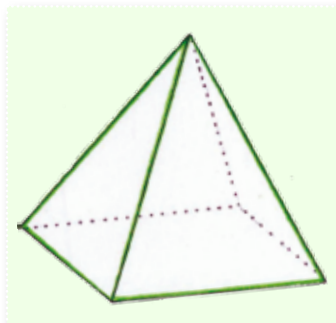
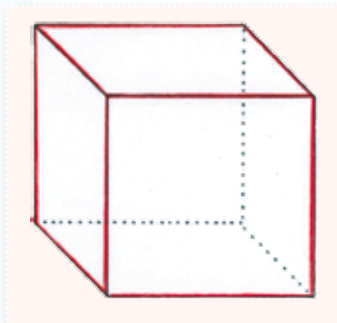

ime:	
koliko?	
kutov:	
bridov:	
površin:	

ime:	
koliko?	
kutov:	
bridov:	
površin:	

ime:	
koliko?	
kutov:	
bridov:	
površin:	





**Kauboj
pije!**



**Princ
se igra!**



**Princeska
tanca!**



**Mačka
jači!**



**Klaun
skače!**



**Šerif
čita!**



**Viška
pije!**



**Kauboj
tanca!**



**Črljen-
kapica
čita!**



**Indijanac
jači!**

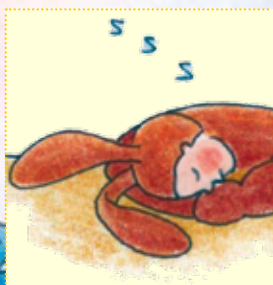

**Čarobnjak
žonglira!**

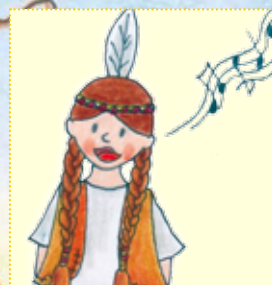

**Kuhar
skače!**



**Zec
spava!**



**Kuharica
spava!**



**Miš
se igra!**

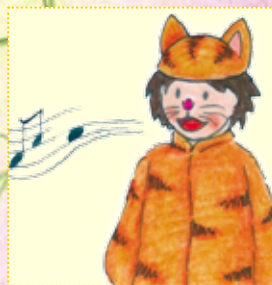

**Miš
žonglira!**

Skači gumicom!

Gibanje i šport

Troja dica tribaju 1 gumicu, ka/koja je oko 2m duga i 1cm debela.
Povežite ju na kraji skupa!

Dvoja dica ju nategnu nogami.

Treće dite skače dvimi nogami najjednoč u ritmu zbrajalice.

Gledaj na slike!

Ako se dotakneš gumice, je drugo dite na red.

Kada su svi bili na redu, se gumica podigne više.

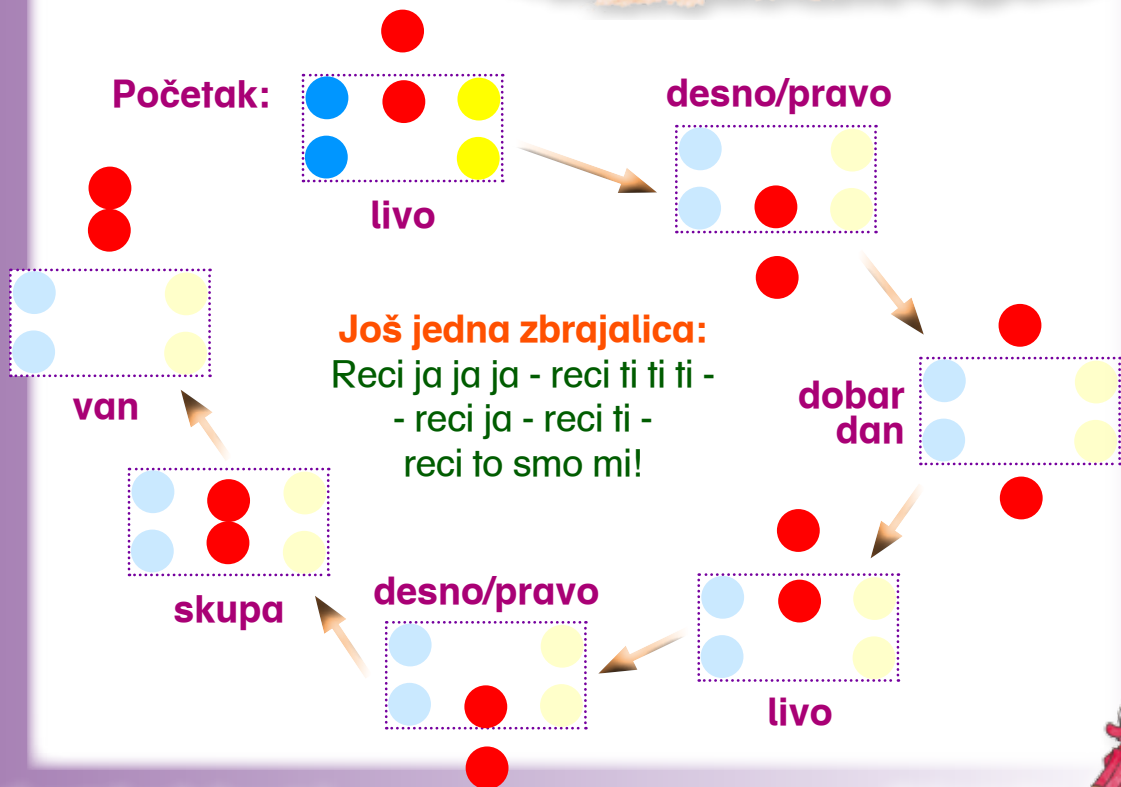

Još jedna zbrajalica:
 Reci ja ja ja - reci ti ti ti -
 - reci ja - reci ti -
 reci to smo mi!



Mesopusne maske

Dobru i lipu zabavu!

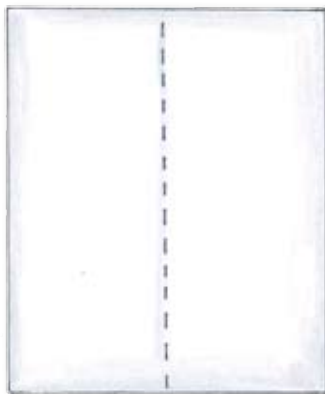

Ti pravaš:

- bijeli list (A 3)
- olovku i brisalicu
- škare
- vodene farbe
- male iglice



Djelaj ovako:

Prekreni list u sredini!

Namoljaj samo pol obraza na list
(vlase, jedno oko, pol nosa, pol ust i pol brade)!

Onda izriži masku!

Pri oku moraš prebosti list i pažljivo rizati.

Pofarbij masku različnim farbama!

Čekaj, dokle se farbe usušu!

Na zadnje zami iglice i ubisi svoju masku u razredu!



H
J
K
U

Andjeo je rekao Jožefu da pobigne u Egipat. Kako ćedu sigurno stignuti u Egipat? Zač/Zašto su morali pobignuti?
Ako najdeš pravilne slove i je napišeš u ormarić, imaš odgovor!

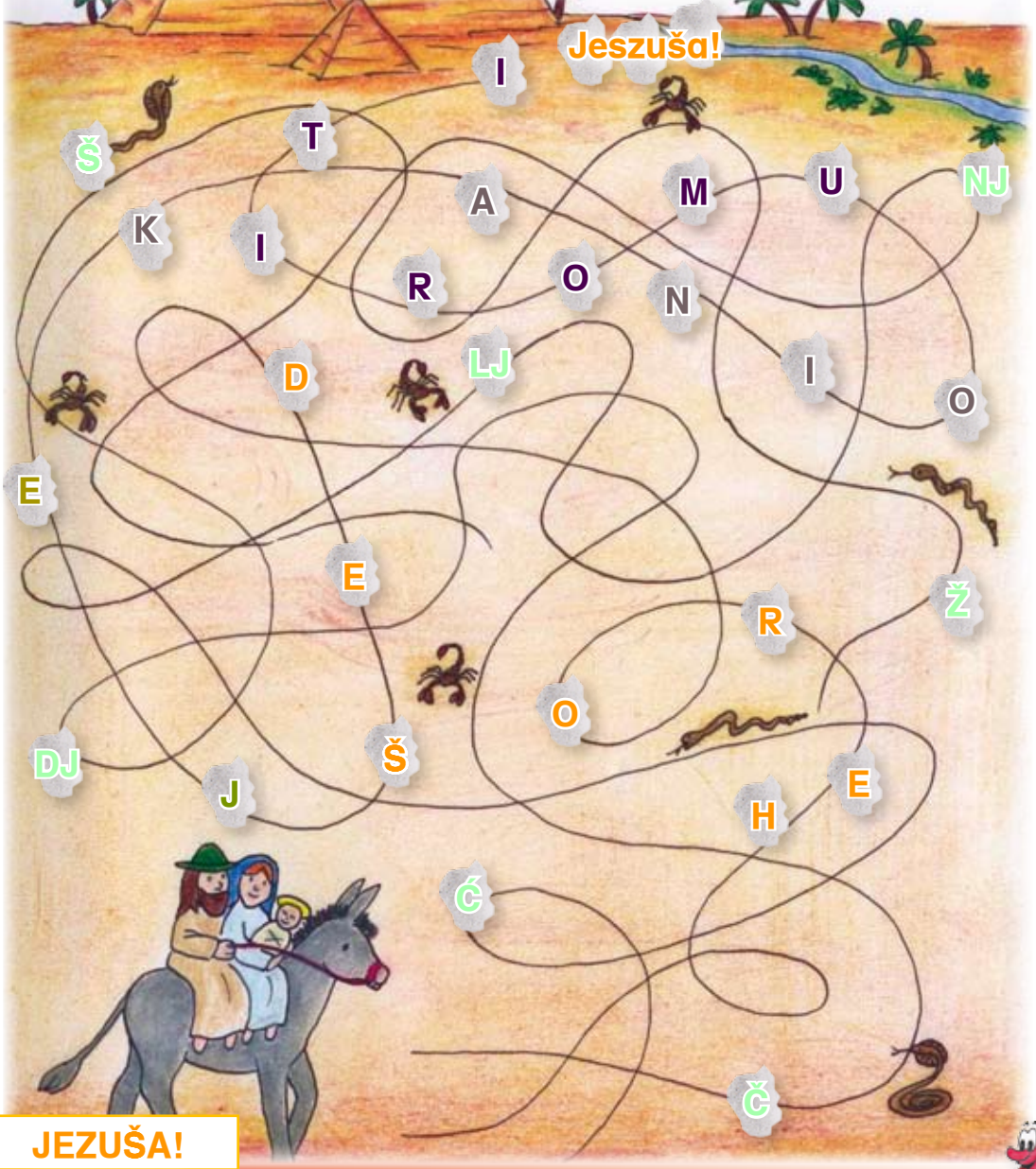

Kad je Herodeš umro, se je vratila Sveta obitelj opet u Nazaret.
Jožef je djelao kot drivodjelac.

**Moreš li najti u njegovoj radionici sedam pogriškov?
Prekriži i napiši riči u tvoju pisanku!**



Gustav Klimt

(1862 – 1918)

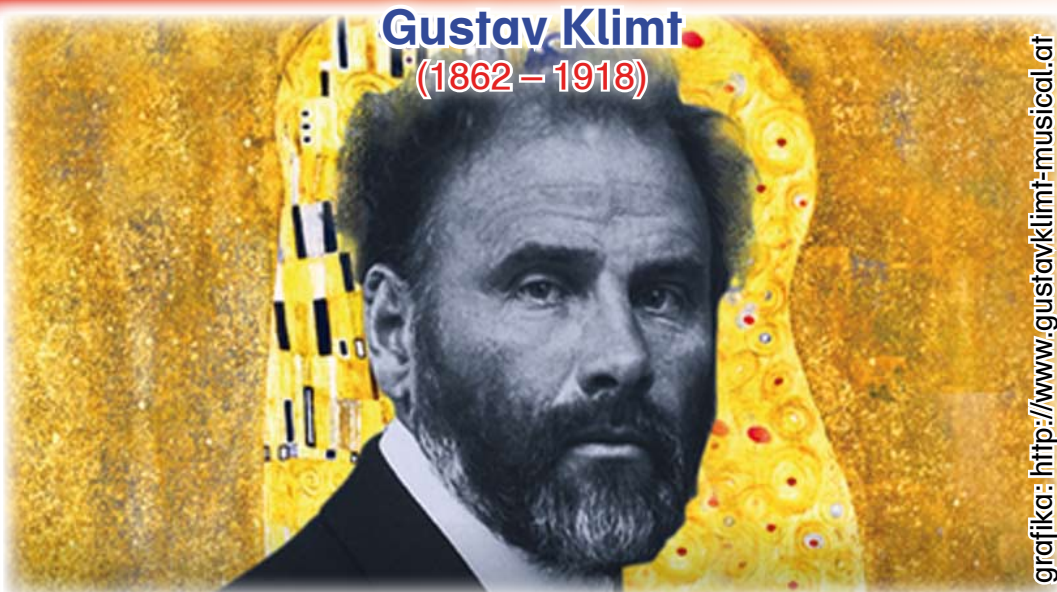

grafika: <http://www.gustavklimt-musical.at>

Precrtalj nepravilne izjave!

U prošlom ljetu smo slavili **S**) 150 ~~T~~) 250. obljetnicu Klimtovoga rođenja. Gustav Klimt je živio **E**) u Beču **F**) u Solnogradu. **C**) U ljeti **D**) U zimi je bio na jezeru u Gornjoj Austriji (Attersee). **D**) Klimt je bio oženjen, ali nije imao dice. **E**) Klimt nije bio oženjen, ali je imao već dice. Klimt je bio umjetnik, ki/koje je glavno slikao **R**) u naturi **S**) u ateljeu. Glavno je slikao **S**) žene **T**) cvijeće. Njegova najdraža farba je bila **G**) črna **H**) zelena **I**) zlata farba. Nosio je rado **N**) ugodne hlače **O**) dužičke haljine. Njegova najpoznatija slika se zove **N**) poljubac **O**) objamljenje.

Ako napišeš pravu slovu u kocku, ćeš doznati, ko/koje umjetno društvo je utemeljio Gustav Klimt!

W	I	E	N	E	R	S							
---	---	---	---	---	---	---	--	--	--	--	--	--	--





Klimt je slikao lijepe žene. Njeva oprava je imala svenek izvanredne mustre i farbe. Pofarbaj opravu ove žene po svojem ukusu.

Tip: Zalipi sliku na papir i napravi sliku u Klimtovom stilu kot su to djelali školari i školarice trećega/tretoga razreda Dvojezične nove sridnje škole Veliki Borištof!



školarica Sabina Kukuljac



školar Daniel Kuzmits



pofarbati opravu
pokusiti napraviti Klimtov stil

minimulti novi moj

Naše Gradišće

Kotari i automobilne pločice.
Ispuni, ča/što skupa sliši!

 ND  Niuzaljski kotar

  Novogradski kotar

  Bortanski kotar

  Željezanski kotar

  Gornjopuljanski kotar

  Matrštofski kotar

  Jenrštofski kotar

  Grad Željezno i





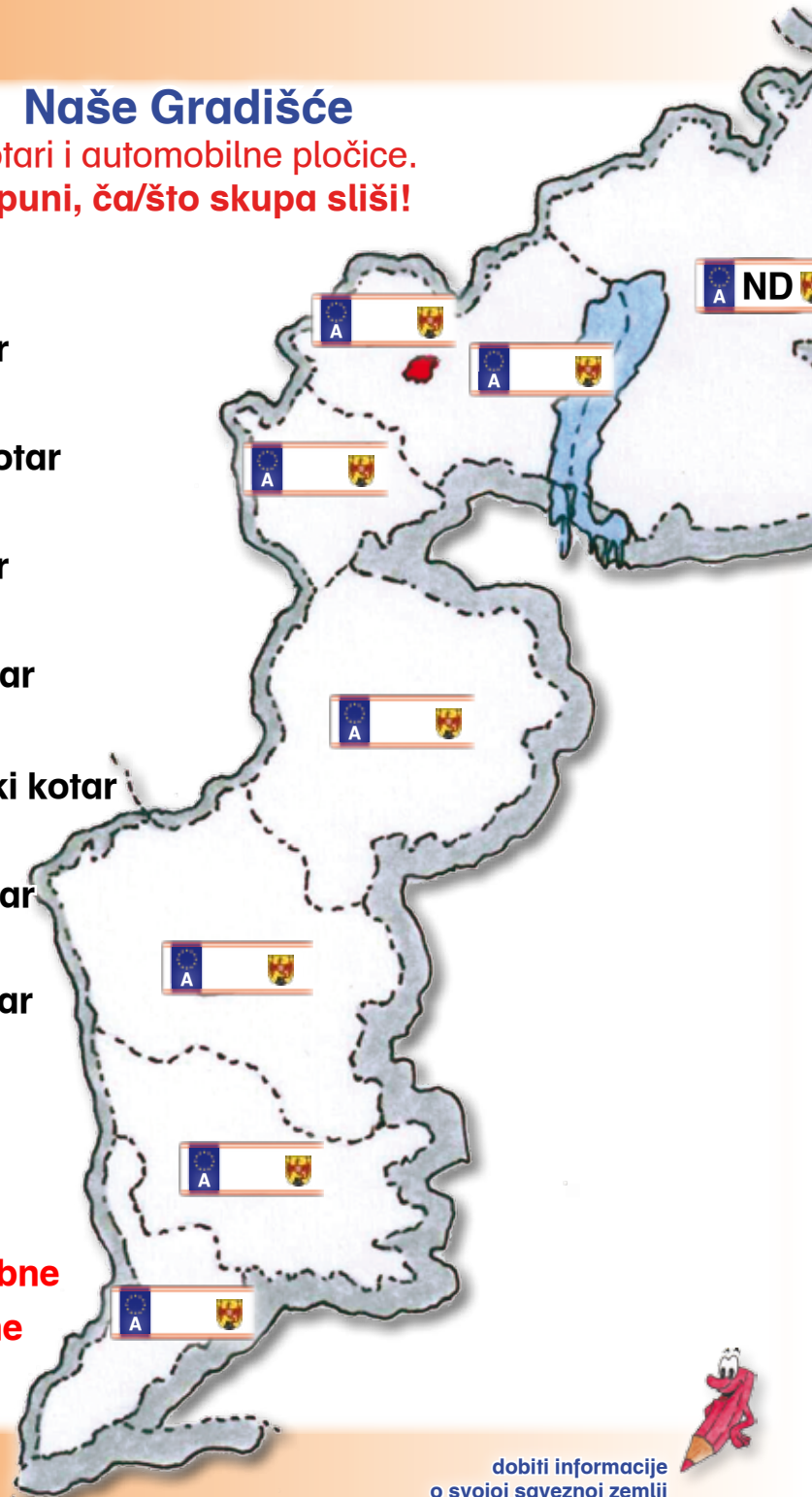





  Ruša









imaju posebne
automobilne
pločice!



Sudoku notov

Ke/Koje note falu? Ispuni sudoku!

Idemo se šijati!

Ča/Što se triba pri šijanju? Okruži ili prekriži!

Vježbaj ovako: Tribam kacigu. Tribam ...



kaciga

krljača

anorak

očalji
za šijanje

cipele za šijanje

očalji
za ronjene

rukavice

hlače/plundre

šiji

šal

sandali

Upoznaj
moj kalendar!

Naš tip: Zidni kalendar 2012./13.

Memo u školi

Svaki razred je dostao kalendar s naslovom „Memo u školi“. U ovom kalendaru vas Memo na šalni način pelja kroz školsko ljeto.

Čuda veselja pri učnji!



Izdavač ovoga kalendara je
Hrvatski kulturni
i
dokumentarni centar.

www.croates.at

hkdc@croates.at

upoznati zidni kalendar
Memo u školi



minimulti novi moj

Kompjutorski „a-b-c“

„paint it!“ slikovni program za dicitu

Poduzeće Microsoft je napravilo jedan program, kade dica moru na jednostavni i šalni način upoznati principe za slikanje/moljanje na kompjutoru.

Ov program ima skoro sve mogućnosti, ke/koje ima i slikovni program za odrasle, samo na dičjoj razini. **Paint it!** se ne treba inštalirati, samo krenuti iz medijuma; zanimljivo i šalno i za odrasle, ki/koji se rado bavu grafikom na kompjutoru. U svitskoj digitalnoj mriži egzistiraju slobodne verzije ovoga produkta, samo se mora iskati na tražilici.



Kazalo

Dani tajedna.....	2
Dobe dana.....	3
Snižne pahuljice letu.....	4
Oblići snigoviće.....	5
Na mesopusnom balu.....	6
Mesopusna ganjka.....	7
Snigović.....	8
Šalna pitanja.....	9
Snigovići.....	10
Matematična tijela.....	11
Mesopusni domino ili memori.....	12
Mesopusni domino ili memori.....	13
Skači gumicom!.....	14
Mesopusne maske.....	15
Institit za vjerskopedagošku izobrazbu.....	16
Institit za vjerskopedagošku izobrazbu.....	17
Gustav Klimt - prinos NSŠ Veliki Borištof.....	18
Gustav Klimt - prinos NSŠ Veliki Borištof.....	19
Naše Gradišće.....	20
Sudoku notov.....	21
Idemo se šijati!.....	22
Naš tip: Zidni Kalendar 2012./13.....	23
Kompjutorski „a-b-c“ „paint it!“.....	24



Vlasnik i izdavač / Medieninhaber und Herausgeber: © 2013. HNVŠ
Narodna visoka škola gradišćanskih Hrvatov - <http://www.vhs-croates.at>
Volkshochschule der burgenländischen Kroaten, 7000 Eisenstadt, J. Permyerstr. 9



Odgovorno uredničvo: Arth Elfriede, Billisits Martina, Bunyai, MAS, MSc Stefan, Buranits Helene, Dorner Patricia, Heisinger, Mag. Elvira, Imre Manuela, Marlovits Michael, Marlovits Heidemarie, Sagmeister Juliane, Varga Marlen, Zsvikovits Silvia

Lektorica: Mag.^{na} Edith Mühlgaszner, MAS, HRⁱⁿ, LSⁱⁿ i.R.

Ilustracije: Gabriel Jasmine - **Layout i slog:** Bunyai, MAS, MSc Stefan

Opoš minimulti digital: <http://www.bildungserver.com/schulen/minimulti/default.htm>

Poštanski ured ishadjanja: 7000 Željezno, **Tiskara:** Wograndl Druck, 7210 Matrštof

Izjava polag Zakona o mediji: „moj novi minimulti“ je časopis za školare/školarice u Gradišću.

Erklärung gemäß Mediengesetz: „moj novi minimulti“ ist eine Zeitschrift für SchülerInnen im Burgenland, verfasst in kroatischer Sprache. Gefördert vom **Bundeskanzleramt** aus Mitteln der Volksgruppenförderung.

minimulti
digital

